



INSTRUCTIONS

International Version

*P.O. Box 368 – 908 West Main
Laurel, MT USA 59044
phone 800-548-7341
phone 406-628-8231
fax 406-628-8354*

MODEL NUMBER: _____

SERIAL NUMBER: _____

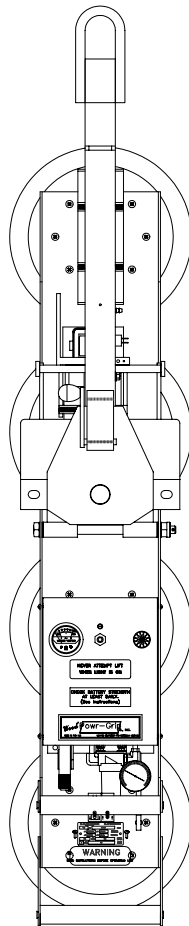

SINGLE-CHANNEL LIFTER
DC-VOLTAGE



***READ ALL INSTRUCTIONS AND WARNINGS
BEFORE OPERATING THIS LIFTER***



SPECIFICATIONS

Description:	Designed for use with a crane or other hoisting equipment, P1-04DC lifters employ vacuum to hold a load for lifting, and they provide manual 180° rotation and manual 90° tilt movements for load manipulation.		
Model Number:	P11004DC	P1HV1104DC	P11104DC
Vacuum Pads:	10" [25 cm] nom. diameter, concave (Model G0750) - Four, 55 durometer natural-polybutadiene rubber, with	10" [25 cm] nom. diameter, lipped (Model HV11) ¹	11" [28 cm] nom. diameter, lipped (Model G3370) #60 filter screen -
Pad Spread: (to outer edges)	49" x 10" [1245 mm x 254 mm]	50" x 11" [1270 mm x 280 mm]	51" x 12" [1295 mm x 305 mm]
Load Capacity: (rated at 16" Hg [-54 kPa] on clean, smooth, nonporous flat surfaces ²)			
Per-Pad:	150 lbs [68 kg]	150 lbs [68 kg]	175 lbs [79 kg]
Maximum:	600 lbs [270 kg]	600 lbs [270 kg]	700 lbs [320 kg]
Lifter Weight:	65 lbs [30 kg]	74 lbs [34 kg]	70 lbs [32 kg]
Power Source:	12 volts DC, 8 amps (for each pad channel)		
Battery Capacity:	7 amp-hours		
Rotation Capability:	Manual, 180°, with automatic locking at each ¼ revolution (when desired)		
Tilt Capability:	Manual, 90°, with automatic locking in vertical position		
Vacuum Pump:	Diaphragm type, 1 SCFM [28 liters/minute] nominal airflow		
Vacuum Reserve Tank:	Vacuum reservoir helps prevent immediate vacuum loss in case of power failure and extends battery life by reducing pump cycles required to maintain vacuum.		
Vacuum Gauge:	Dial gauge indicates current vacuum level in positive inches of Hg and negative kPa.		
Low Vacuum Warning Light:	Red light is energized until vacuum level is sufficient to lift maximum load weight (higher than 16" Hg [-54 kPa]) and whenever vacuum loss causes pump to re-engage.		
Options:	See appendix for instructions about optional features.		
Operating Elevation:	Maximum = 6000 feet [1828 meters]		
Operating Temperatures:	15° to 105° F [-9° to 40° C]		
Fatigue Life:	In accordance with CE Standard EN 13155, this lifter is designed to have a minimum fatigue life of 20,000 lifting cycles.		

CE Note: This symbol appears in the *INSTRUCTIONS* manual only when requirements of a CE Standard are *different* from requirements of other standards that also apply to this vacuum lifter. CE requirements are mandatory in geographical areas where CE Standards apply, but may be optional in other locations.

¹ Available with optional closed-cell foam rings for applications on rough or textured surfaces.

² Load Capacity is based on a friction coefficient of 1; see MAINTENANCE: VACUUM PAD MAINTENANCE: Friction Coefficient for additional information.

WARNINGS



Powr-Grip is pleased to offer the most reliable vacuum lifters available. Despite the high degree of security provided by this product, certain precautions must be observed to protect the operator and others.



- Always** wear personal protective equipment that is appropriate for the material being handled. Follow trade association guidelines.
- Always** operate the lifter under conditions approved for its design (see INTENDED USE: OPERATING ENVIRONMENT).
- Never** operate a lifter that is damaged, malfunctioning, or missing parts.
- Never** operate a lifter if the sealing edge of any vacuum pad is cut or otherwise damaged.
- Never** remove or obscure warning labels.
- Never** operate a lifter if the Load Capacity or any warning appears to be missing or obscured.
- Always** make certain the contact surfaces of the load and all vacuum pads are clean prior to applying the pads (see MAINTENANCE: VACUUM PAD MAINTENANCE).
- Never** exceed the Load Capacity or attempt to lift loads the lifter is not designed for (see INTENDED USE: LOAD CHARACTERISTICS).
- Never** attempt to lift cracked or broken glass with this lifter.
- Always** position the vacuum pads correctly on the load prior to lifting (see OPERATION: TO APPLY THE PADS TO A LOAD).
- Never** lift a load when any vacuum indicator shows inadequate vacuum.
- Never** touch the vacuum release controls during a lift. This may result in loss of attaching vacuum and release of the load.
- Never** allow people to ride on the lifter or the load being lifted.
- Never** lift a load higher than necessary or leave suspended loads unattended.
- Never** lift a load over people.
- Always** keep other personnel far enough away from the lifter to avoid injury in the event of an unexpected load release.
- Always** place the power control in the inactive position and, when possible, disconnect the power source before opening any enclosure on the lifter. (Only applicable to powered lifters)
- Always** remember that modifications to the lifter may compromise its safety. Wood's Powr-Grip cannot be responsible for the safety of a lifter that has been modified by the customer. For consultation, contact Wood's Powr-Grip.
- Never** release both the rotation latch and the tilt latch at the same time.

OPERATING FEATURES

Note: Components featured in the following instructions for assembling, operating or maintaining the vacuum lifter are underlined> on their first appearance in each section.

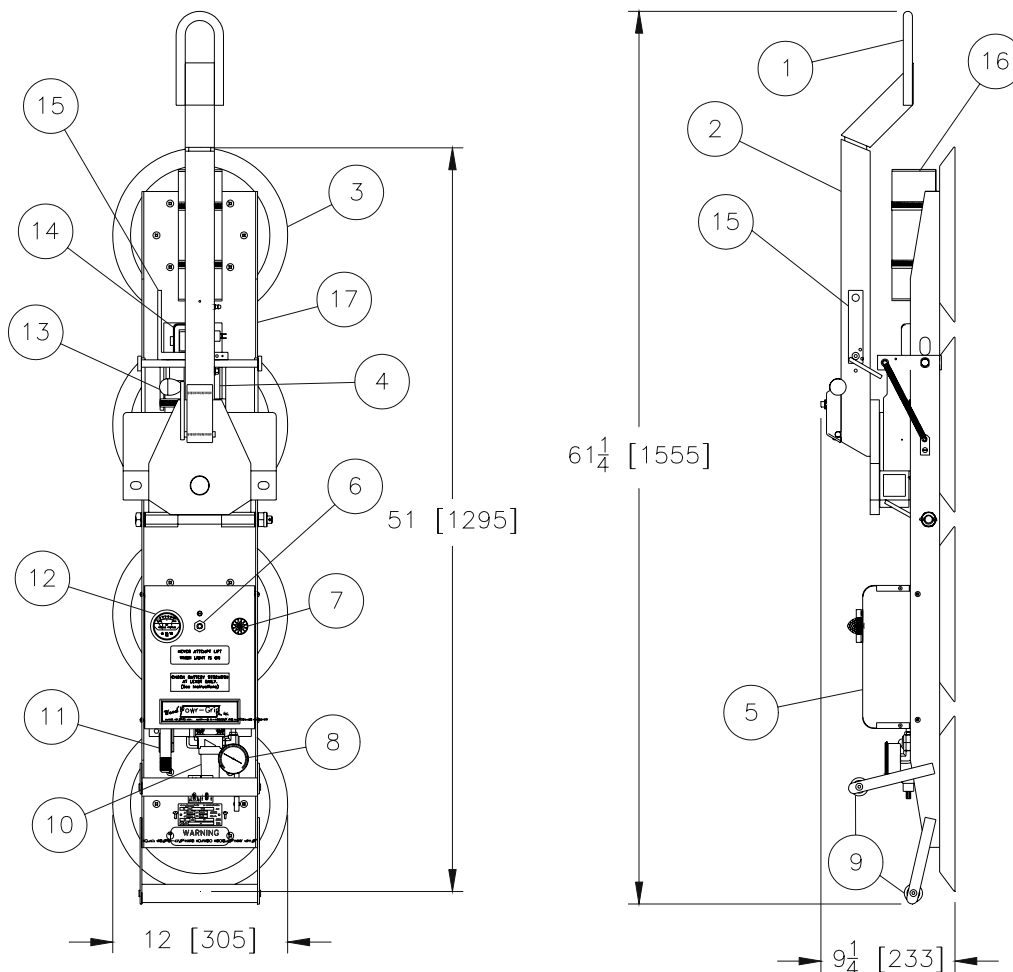

Standard P11104DC shown.

- | | | |
|---|----------------------------|---------------------------|
| 1 LIFT BAIL | 6 BATTERY TEST BUTTON | 12 BATTERY GAUGE |
| 2 LIFT BAR | 7 LOW VACUUM WARNING LIGHT | 13 ROTATION RELEASE LEVER |
| 3 VACUUM PAD | 8 VACUUM GAUGE | 14 BATTERY CHARGER |
| 4 BATTERY | 9 CONTROL HANDLES | 15 TILT RELEASE LEVER |
| 5 ENCLOSURE with VACUUM PUMP
and VACUUM SWITCH | 10 AIR FILTER | 16 VACUUM RESERVE TANK |
| | 11 VALVE HANDLE | 17 PAD CHANNEL |

ASSEMBLY

- 1) Open the shipping container and remove all devices for restraining the vacuum lifter during shipping. Save the container for use whenever the lifter is transported.
- 2) Suspend the lifter from a crane as follows: Select hoisting equipment (crane and hoist, when applicable) rated to carry the maximum load weight plus the lifter weight (see SPECIFICATIONS: Maximum Load Capacity and Lifter Weight).

Note: Any application of the lifter must conform to all statutory or regulatory standards that relate to the hoisting equipment when used in its geographical location (eg, relevant OSHA standards in the USA).

Release the tilt latch (see OPERATION: To TILT THE LOAD) and raise the lift bar to a vertical orientation. Then attach the hoisting equipment hook to the lift bail.

 **WARNING: Hoisting equipment hook must be fitted with restraining latch to prevent lift bail from slipping off under any circumstances.**

Note: It may be desirable to attach a short cable choker between the hoisting equipment hook and the lift bail, as large hooks may interfere with the pad channel during rotation.

 **WARNING: Cable choker must be rated to carry maximum load weight plus lifter weight.**

Use the hoisting equipment to raise the lifter out of the shipping container. Be careful to avoid damaging any vacuum pads. Remove the pad covers and save them for use whenever the lifter is stored.

- 3) Connect the electrical connector uniting the battery to the vacuum generating system. The lifter is now operational.
- 4) Perform Operational and Load Tests for the lifter as directed in MAINTENANCE: TESTING SCHEDULE.

INTENDED USE

LOAD CHARACTERISTICS

 **WARNING:** *This lifter is NOT intended for lifting hazardous materials, such as explosives or radioactive substances.*

The operator must verify that the lifter is intended to handle each load, in accordance with the following requirements:

- The load must not exceed the maximum allowable weight specified under Load Capacity (see SPECIFICATIONS).
- The load must be a single piece of nonporous or semiporous material with a flat and relatively smooth contact surface.³ To determine whether the load is too porous or rough, perform the test under Vacuum Level on Other Surfaces (see OPERATION: TO APPLY THE PADS TO A LOAD).
- The load's contact surface must be suitable for obtaining a friction coefficient of 1 with the lifter's vacuum pads (see MAINTENANCE: VACUUM PAD MAINTENANCE: Friction Coefficient), as verified by a friction test.⁴ If necessary, contact Wood's Powr-Grip for help in conducting a friction test.
- While the *minimum* length and width of the load are determined by the Pad Spread (see SPECIFICATIONS), the *maximum* length and width are determined by the allowable overhang, or the amount of load material that can extend sideways beyond the vacuum pads without breaking or otherwise being damaged.

The allowable overhang depends on the kind of load material being lifted, the thickness of the material, and the angle at which it is handled (if any). Since materials such as glass, stone or sheet metal each have different physical properties, the allowable overhang must be evaluated separately for each type of load. If necessary, contact Wood's Powr-Grip or an authorized dealer for help in determining the recommended overhang in a specific situation.

- 1" [2.5 cm] is the maximum allowable thickness of loads at the maximum weight (see SPECIFICATIONS: Load Capacity).⁴ However, allowable thickness increases as load weight decreases. If necessary, contact Wood's Powr-Grip for help in determining the maximum thickness permitted when handling any specific load.

Note: Vacuum pads can stain or deform load surfaces with light colors or soft coatings. The operator should test such surfaces for detrimental effects before using the lifter on them.

³ Lifters that feature concave vacuum pads can also attach to some kinds of curved loads. Since curvature affects the lifting capacity, contact Wood's Powr-Grip for help in determining the Load Capacity for a particular curved load.

⁴ Flat Lifters are exempt from this requirement.

OPERATING ENVIRONMENT

The operator must determine whether the lifter is intended to be used in each work environment, in accordance with the following restrictions:

 **WARNING: Never use lifter in dangerous environments.**

- This lifter is not intended for use in any environment that is inherently dangerous to the operator or likely to compromise the lifter's ability to function. Environments containing explosives, caustic chemicals and other dangerous substances must be avoided when using the lifter.
- The lifter's work environment is limited by the Operating Elevation and Operating Temperatures indicated in SPECIFICATIONS.
- Using the lifter in wet environments may require the operator to take special precautions:
Moisture on contact surfaces of the load or vacuum pads diminishes the lifter's slip resistance, thereby reducing the lifting capacity (see MAINTENANCE: VACUUM PAD MAINTENANCE: Friction Coefficient).

 **WARNING: Moisture reduces slip resistance of vacuum pads.**

Although the lifter's exterior surfaces can tolerate some exposure to water vapor, they are not designed to be water-tight. Submerging the lifter or using it in rain may damage lifter components; these and similar conditions must be avoided.

CE

- If the lifter is employed in a construction area, CE Standard 13155 requires the use of a secondary positive holding device, such as a sling system, designed to support the load in case of a vacuum system failure.

 **WARNING: Where CE Standards apply, secondary positive holding device is required for lifting loads in construction zones.**

OPERATION

BEFORE USING THE LIFTER

The operator must determine whether the lifter is capable of performing each intended task, in accordance with the SPECIFICATIONS and INTENDED USE sections of this *INSTRUCTIONS* manual. In addition, all of the following preparations must be completed prior to lifting any load.

Taking Safety Precautions

The operator must read and understand this *INSTRUCTIONS* manual, including all **WARNINGS**, before using the lifter. If necessary, contact Wood's Powr-Grip or an authorized dealer for assistance.

⚠ WARNING: *Always wear appropriate personal protective equipment.*

The operator must wear any personal protective equipment and take any other precautions required to handle the load safely. Consult appropriate trade association guidelines to determine what precautions are necessary for each type of load material.

Performing Inspections and Tests

⚠ WARNING: *Always check battery energy before using lifter.*

(See MAINTENANCE: BATTERY TEST)

Perform all inspections and tests required by the INSPECTION and TESTING SCHEDULES (see MAINTENANCE). In addition, if the lifter has been in storage, always conduct a VACUUM TEST before placing it in service (see MAINTENANCE).

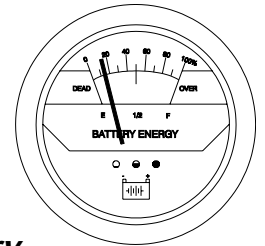

CAUTION: *Examine each air filter regularly, and empty when necessary.*

The lifter is equipped with one or more air filters to help protect the vacuum system from contaminants.⁵ In order for a filter to function, the operator must empty the filter bowl before enough liquid accumulates to contact any portion of the filter element (see MAINTENANCE: AIR FILTER MAINTENANCE).

⁵ In order for the operator to use the lifter on wet load surfaces, it must be equipped with 2 or more filters that are connected *in series*. However, see MAINTENANCE: VACUUM PAD MAINTENANCE: Friction Coefficient before using the lifter on wet load surfaces.

TO APPLY THE PADS TO A LOAD

Positioning the Lifter on the Load

Make certain that the contact surfaces of the load and all vacuum pads are free of any contaminants that could prevent the pads from sealing against the load (see MAINTENANCE: VACUUM PAD MAINTENANCE). Center the lifter's rotation axis to within 2" [5 cm] of the load center, since off-center loading can cause the load to rotate or tilt unexpectedly, and it may also damage the lifter.⁶ Make sure that all vacuum pads will fit entirely on the load's contact surface (see SPECIFICATIONS: Pad Spread) and that they will be loaded evenly while lifting (see SPECIFICATIONS: Per-Pad Load Capacity). Then apply the lifter to the load so that all pads are touching the contact surface.

Sealing the Pads against the Load

Firm pressure at the center of the lifter helps the vacuum pads begin to seal against the load. Pull the valve handle outward to the "APPLY" position (power on). This energizes the vacuum pump, causing vacuum to be drawn at the pads immediately. The red low vacuum warning light also turns on and remains illuminated until the lifter attains sufficient vacuum to lift the

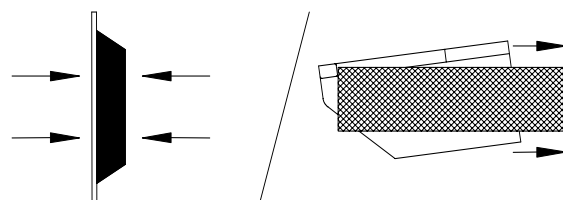

TO APPLY

maximum load weight (see TO LIFT AND MOVE THE LOAD: Load Capacity and the Warning Light to follow). The valve handle must remain in the "APPLY" position throughout the entire lift.

⚠ WARNING: Keep valve handle in "APPLY" position throughout lift.

Note: If a vacuum pad has been lying against a hard object (as during shipping), it may be slightly distorted. Although initially it may be difficult to apply the pad to a load, this condition should correct itself with continued use.

Reading the Vacuum Gauge

The vacuum gauge indicates the current vacuum level in the lifter's vacuum system. The *green* range indicates vacuum levels sufficient for lifting the maximum load weight, whereas the *red* range indicates vacuum levels that are **not** sufficient for lifting the maximum load weight. The gauge needle should show a sudden surge in vacuum as the vacuum pads seal against the load. If it takes more than 5 seconds for the vacuum level to reach 5" Hg [-17 kPa], press on any pad that has not yet sealed.

⁶ The lifter is designed to handle the maximum load weight (see SPECIFICATIONS: Maximum Load Capacity) when the load's center of gravity is positioned within 2" [5 cm] of the lifter's rotation axis. Occasional loading deviations are permissible, provided that the operator can maintain control of the load at all times and that the load weight is low enough to avoid damaging the lifter.

Vacuum Level on Optimal Surfaces

When the lifter is attached to clean, smooth, nonporous load surfaces, it should be able to maintain a vacuum level in the green range on the vacuum gauge, except when used at high elevations (see SPECIFICATIONS: Operating Elevation). If not, make sure the vacuum switch is adjusted correctly (see MAINTENANCE: VACUUM SWITCH ADJUSTMENT). If the vacuum switch cannot be adjusted to maintain a vacuum of 16" Hg [-54 kPa], perform the VACUUM TEST (see MAINTENANCE) to determine whether there is a deficiency in the vacuum generating system.

Vacuum Level on Other Surfaces

When the lifter is attached to contaminated, rough or porous load surfaces, it may not be able to maintain a vacuum level in the green range on the vacuum gauge, due to leakage in the seal between the vacuum pads and the load surface.⁷ In the case of contamination, thoroughly clean the contact surfaces of the load and the vacuum pads (see MAINTENANCE: VACUUM PAD MAINTENANCE: Cleaning), and reapply the lifter to the load. If the load has rough or porous surfaces, ***the operator must conduct a test to determine whether the lifter is designed to lift the load***, as follows:

- 1) Make sure the lifter's vacuum generating system is functioning correctly (see MAINTENANCE: VACUUM TEST).
- 2) Apply the vacuum pads to the load as previously directed.
- 3) After the vacuum pump stops running, disconnect the electrical connector uniting the battery with the vacuum generating system.

Note: After the test is completed, move the valve handle to the "RELEASE" position (power *off*) before reconnecting the battery.

- 4) Raise the load a minimal distance, to assure that it is supported by the lifter.
- 5) Monitor the vacuum gauge while the load is suspended for 5 minutes: ***The lifter must maintain a minimum vacuum level of 10" Hg [-34 kPa] during this time.*** If not, the load does not possess the characteristics required for using this lifter.⁸

⁷ Contaminated loads can also cause the vacuum pump to run frequently or continuously. Since excessive pumping quickly reduces battery energy, the operator should clean the load when possible, to minimize pumping.

⁸ Certain load materials are too rough or porous to allow the lifter to form a seal which can be maintained for 5 minutes without power. However, in geographical locations where CE Standards do not apply, it may be possible to use the lifter to lift such loads. Contact Wood's Powr-Grip for more information.

TO LIFT AND MOVE THE LOAD

Positioning the Lift Bar

⚠ WARNING: *Lift bar must be oriented vertically to lift load.*

Never lift the load from a flat position with the lift bar latched parallel to the load. Always release the tilt latch (see TO TILT THE LOAD to follow) and raise the lift bar to a vertical orientation before attempting to lift.

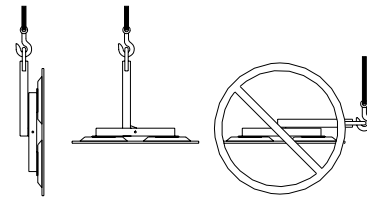

Load Capacity and the Warning Light

A lifter's Load Capacity is rated at a vacuum level of 16" Hg [-54 kPa] (see SPECIFICATIONS). After the lifter has attained this level, the vacuum pump turns off automatically, to conserve battery energy. At the same time, the low vacuum warning light turns off, to indicate that the lifter is ready to lift the maximum load weight.

⚠ WARNING: *Never attempt to lift load while red warning light is illuminated.*

Do not attempt to lift the load while the warning light is illuminated; such an attempt could result in a load release and possible injury to the operator.

Monitoring Vacuum Indicators

The low vacuum warning light and the vacuum gauge must remain completely visible to the operator, so that they can be monitored throughout the entire lift.

⚠ WARNING: *Vacuum indicators must be visible to operator throughout entire lift.*

If the vacuum system experiences leakage while the lifter is attached to the load, the vacuum pump turns on automatically, as required to maintain sufficient vacuum for lifting the maximum load weight. The low vacuum warning light also turns on and remains illuminated while the pump is running, to signal the reduction in vacuum to the operator.

If the pump and warning light turn on while you are lifting a load, make sure the vacuum gauge shows a vacuum level of 16" Hg [-54 kPa] or higher. If not, move away and stay clear of the load until it can be lowered to the ground or a stable support.

⚠ WARNING: *Stay clear of any suspended load while vacuum level is lower than 16" Hg [-54 kPa].*

Discontinue lifter use until the cause of the vacuum loss can be determined. If the pump runs at intervals of ten minutes or less while the lifter is attached to clean, smooth, nonporous materials, the leakage is likely to be in the vacuum system. In this event, perform the VACUUM TEST (see MAINTENANCE) and inspect the vacuum pads for damage (see MAINTENANCE: VACUUM PAD MAINTENANCE: Inspection). If the vacuum loss cannot be remedied immediately, perform inspection and maintenance as needed to identify and correct any deficiency before resuming normal operation of the lifter.

Controlling the Lifter and Load

When the vacuum indicators show that the lifter is ready, use the hoisting equipment to raise the lifter and load as needed to clear any obstacles in their path. Use the control handle to keep the lifter and load in the desired orientation while they are suspended from the crane. Once sufficient clearance is established, the load can be rotated or tilted as desired (see TO ROTATE THE LOAD EDGEWISE or TO TILT THE LOAD to follow).

In Case of Power Failure

The lifter is equipped with a vacuum reserve tank, designed to maintain vacuum temporarily in case of a failure at the lifter's power source.

⚠ WARNING: *Stay clear of any suspended load in the event of a power failure.*

Although the lifter is designed to support the load for at least 5 minutes without power, this depends on many factors, including the condition of the load and the lifter's vacuum system (see INTENDED USE: LOAD CHARACTERISTICS and MAINTENANCE: VACUUM PAD MAINTENANCE, VACUUM TEST). If a power failure occurs, keep all personnel clear of the suspended load until it can safely be placed on the ground or a stable support. Correct any deficiency before resuming normal operation of the lifter.

To ROTATE THE LOAD EDGEWISE

⚠ WARNING: *Never release tilt and rotation latches at the same time. Releasing both latches may result in damage to the lifter and/or loss of the load.*

⚠ WARNING: *Do not attempt to rotate from tilted position.*

⚠ WARNING: *Make sure load is positioned correctly on lifter; unbalanced loads may rotate unexpectedly.*

Remember that the load is longer in its diagonal dimensions than in its side dimensions; raise the load high enough to clear any obstacles when rotating. Maintain a firm grip on one control handle to keep the load under control at all times. Pull on the rotation release lever to disengage the rotation latch, and rotate the load to the desired position. To stop the load's motion automatically at each quarter turn, simply let go of the rotation release lever immediately after initiating the rotation, so that the rotation latch engages at the next stop. Whenever rotation is not required, keep the rotation latch engaged, to prevent accidental damage to the load and possible injury to the operator.

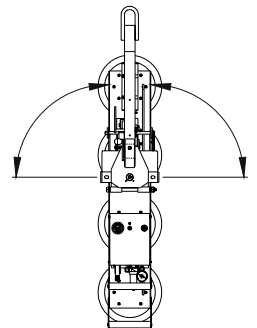

TO TILT THE LOAD

⚠ WARNING: *Never release tilt and rotation latches at the same time. Releasing both latches may result in damage to the lifter and/or loss of the load.*

⚠ WARNING: *Do not attempt to tilt from rotated position.*

Remember that the load requires more vertical space when tilted to the upright position, as well as more horizontal space when tilted to the flat position. Make sure there is sufficient clearance for the load to tilt without contacting the operator or any nearby objects. Latch the pad channel in the center rotation position (tilt is not designed to function in either side position). Maintain a firm grip on one control handle to keep the load under control at all times. Pull on the tilt release lever and prepare for a slight surge of motion as the load begins to tilt. If load size permits, maintain control with the handle throughout the tilt. For loads with overhang, it may be necessary to release the control handle as the load approaches the flat position. If so, keep the load under control using hand cups or other appropriate means.

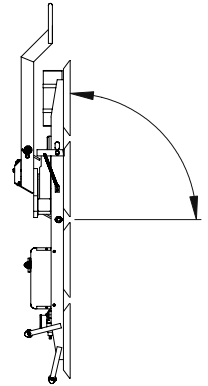

TO RELEASE THE PADS FROM THE LOAD

⚠ WARNING: *Load must be fully supported before releasing vacuum pads.*

When the load is at rest and fully supported, pinch the valve release lever against the valve handle, and push the valve handle inward to the "RELEASE" position (power off) until the vacuum pads disengage completely from the load.

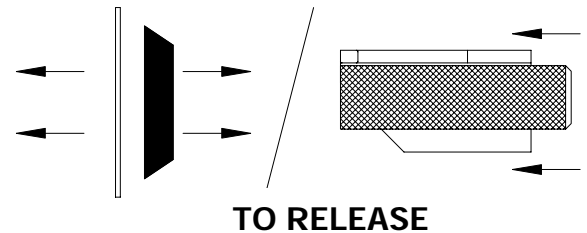

AFTER USING THE LIFTER

Leave the valve handle in the "RELEASE" position (power off).

CAUTION: *Do not set the lifter against any surfaces which could soil or damage the vacuum pads.*

The control handle at the end of the pad channel can be used to support an unloaded lifter when not suspended from a crane: Make sure the pad channel is oriented vertically with the control handle at the bottom. Gently lower the lifter until the control handle supports the entire weight of the lifter. Make sure the lifter leans securely against an appropriate support; then detach the hoisting equipment hook from the lift bail.

If the lifter is transported to another location, use the original shipping container and secure the lifter so as to protect the vacuum pads and all other components from damage while in transit.

Storing the Lifter

Use the covers supplied to keep the vacuum pads clean.

CE In accordance with CE Standard EN 13155, the lifter is designed to rest on relatively horizontal surfaces without tipping over. To store the lifter in this way, set the lifter with the pads facing downward on a clean, smooth, flat surface.

Charge the battery completely when placing it in storage and at six-month intervals thereafter (see MAINTENANCE: BATTERY RECHARGE). After charging the battery, disconnect the electrical connectors uniting the battery to the battery charger and to the vacuum generating system, in order to minimize power drainage. Preferred temperatures for storing the battery are 32° to 70° Fahrenheit [0° to 21° Celsius]. Higher temperatures require the battery to be charged more frequently. Storage at temperatures above 100° Fahrenheit [38° Celsius] should be avoided.

MAINTENANCE

 **WARNING:** Always make sure battery is disconnected before servicing lifter.

INSPECTION SCHEDULE

Perform inspections routinely, according to the following frequency schedule:

Every-Lift Inspection

- Examine the vacuum pads and load surface for contamination or debris (see VACUUM PAD MAINTENANCE to follow).
- Examine the vacuum pads, controls and indicators for visual damage (see VACUUM PAD MAINTENANCE to follow).
- Test the battery for adequate charge (see BATTERY TEST to follow).

If a battery's charge appears to be inadequate, charge and retest the battery (see BATTERY RECHARGE to follow). If any other deficiency is detected during the inspection, correct it before using the lifter and perform the Frequent Inspection to follow.

Frequent Inspection

(following every 20-40 hours' use; or whenever lifter is out of service for 1 month or more)

- Examine the lifter's structure for visual damage.
- Examine the vacuum system (including vacuum pads, fittings and hoses) for visual damage.
- Examine the air filter for conditions requiring service (see AIR FILTER MAINTENANCE to follow).
- Perform the VACUUM TEST to follow.
- Check for unusual vibrations or noises while operating the lifter.

If any deficiency is detected during the inspection, correct it before using the lifter and perform the Periodic Inspection to follow.

Periodic Inspection

(following every 250-500 hours' use; or whenever lifter is out of service for 1 year or more)

- Examine the entire lifter for external evidence of looseness, excessive wear, deformation, cracks, excessive corrosion, dents to structural or functional components, cuts, or any deficiency which might constitute a hazard.
- Keep a written record of all Periodic Inspections.

If any deficiency is detected during the inspection, return the lifter to Wood's Powr-Grip or an authorized dealer for repair (see LIMITED WARRANTY).

Infrequent Use

If a lifter is used less than 1 day in a 2-week period, perform the Periodic Inspection *each time before using the lifter*.

TESTING SCHEDULE

Perform these tests when placing the lifter in service *initially* and *each time following a repair or modification*. Correct any deficiency and retest before using the lifter.

Operational Tests

- Perform the VACUUM TEST to follow.
- Test all features and functions of the lifter (see OPERATING FEATURES, OPERATION and MAINTENANCE).

Load Test

Prove that the lifter can lift 100% of its Maximum Load Capacity (see SPECIFICATIONS), using an actual load or an equivalent simulation.⁹ Employ the following method to test with an actual load:

- 1) Place a test load with appropriate LOAD CHARACTERISTICS (see INTENDED USE) on a stable support. Make sure the load is oriented in the upright position.¹⁰
- 2) Apply the vacuum pads to the load as previously directed.
- 3) After the vacuum pump stops running, disconnect the electrical connector uniting the battery with the vacuum generating system.

Note: After the test is completed, move the valve handle to the "RELEASE" position (power *off*) before reconnecting the battery.

- 4) Raise the load a minimal distance, to assure that it is supported by the lifter.
- 5) Hold the load for 5 minutes. The load must not slip or fall during this time period. If it does, conduct a VACUUM TEST and inspect each vacuum pad as indicated under VACUUM PAD MAINTENANCE: Inspection (see sections to follow). Correct any deficiency that is found and retest the lifter.

Note: See MAINTENANCE topics to follow for additional directions about inspecting and testing specific lifter components.

MAINTENANCE SCHEDULE

Unless specified elsewhere in this *INSTRUCTIONS* manual, the lifter does not require maintenance on a routine basis. Instead, maintenance must be performed whenever a deficiency is indicated by routine inspections or tests. Any maintenance warranted must be performed before resuming normal operation of the lifter.

⁹ ASME Standard B30.20 requires the lifter to be tested to 125% of its Load Capacity.

¹⁰ Flat Lifters are exempt from this requirement.

BATTERY TEST

The lifter is equipped with a battery gauge to help the operator evaluate whether the battery has adequate energy for lifting. Factors such as the condition of the battery, the time required to execute a lift, and the porosity of the load combine to determine how much battery energy is needed. ***It is the operator's responsibility to evaluate these conditions and to make sure the battery has sufficient energy to complete a lift safely.*** Check the battery energy before every lift and also at the end of each day's use, to decide whether a charge is needed (see BATTERY RECHARGE to follow).¹¹ Never use the lifter when battery energy registers lower than 20%, regardless of the estimated energy requirement.

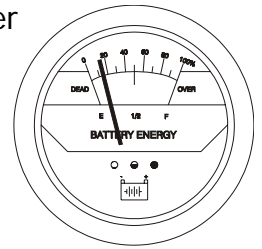

⚠ WARNING: Never use lifter if battery energy is lower than 20% of capacity.

While the valve handle is in the "APPLY" position (power on), the battery gauge automatically monitors battery energy. However, the battery gauge shuts off temporarily to protect the circuitry while the vacuum pump is running. When the pumping cycle is completed, the battery gauge requires a few moments to stabilize before it displays an accurate energy reading again.

While the valve handle is in the "RELEASE" position (power off), the battery energy can be checked manually using the battery test button. If the lifter has not been used since the battery was charged, the battery gauge may falsely indicate an energy level that is higher than actual, due to a "surface charge" on the battery. After the pump runs for approximately one minute, the surface charge dissipates, allowing the operator to take an accurate energy reading.

BATTERY RECHARGE

Only use a battery charger supplied by or approved by Wood's Powr-Grip; other chargers may reduce battery life. Charge the battery as soon as possible after any extended use of the lifter, or whenever the battery gauge indicates diminished energy (see BATTERY TEST preceding). Temperatures above 70° Fahrenheit [21° Celsius] require the battery to be charged more frequently.

CAUTION: Charge the battery only while the valve handle is in "RELEASE" position (power OFF). Operating the lifter when the charger is connected to an AC power source could result in permanent damage to the charger.

Identify the input voltage marked on the battery charger, and plug it in to an appropriate power source.¹² Usually a battery takes no more than 16 hours to charge completely, after which the charger shuts off automatically. Following long-term use, a battery gradually loses capacity. Replace it whenever the operating time between recharging is no longer satisfactory.

¹¹ The battery charger must be disconnected from its AC power source in order to test the battery energy; otherwise, the energy reading on the battery gauge would not be accurate.

¹² Any external power supply must conform to all applicable local codes.

BATTERY CHARGER TEST

Perform this test only when the battery is *not* fully charged (see BATTERY TEST preceding). While the valve handle is in the "RELEASE" position (power *off*) and the battery charger is *disconnected* from any AC power source, use the battery test button to take an energy reading on the battery gauge. Then plug the charger in to an appropriate AC power source and take another energy reading. If the charger is functioning correctly, the energy reading should be higher when the charger is plugged in.

VACUUM PAD MAINTENANCE

Friction Coefficient

The friction coefficient represents the lifter's ability to resist load slippage when the load is oriented in any position except horizontal. If the contact surfaces of either the load or the vacuum pads are not clean, dry and in good condition, slippage is more likely to occur.

The Load Capacity of most Powr-Grip lifters is based on a friction coefficient of 1 (only Flat Lifters are exempt from this requirement). However, a vacuum pad's ability to maintain this friction coefficient is reduced by factors such as contamination, wear, age and exposure to sunlight, as well as the condition of the load's contact surface (see INTENDED USE: LOAD CHARACTERISTICS). Pads that have surface contamination must be thoroughly cleaned (see Cleaning discussion to follow). Over time, the rubber in a pad may experience hardening or leaching of chemicals, resulting in stiffness or surface glaze. Pads that exhibit wear, stiffness or glaze must be replaced. In addition, all pads should be replaced on a regular basis, preferably after no more than 2 years, to ensure that the friction coefficient is not compromised. If necessary, contact your dealer or Wood's Powr-Grip for more information.

Inspection

Inspect each vacuum pad for the following deficiencies routinely, as directed in the preceding INSPECTION and TESTING SCHEDULES. Correct any deficiency before using the lifter.

- Contaminates on the pad face or sealing edges: Soil build-up can prevent pads from sealing adequately or reduce the friction coefficient (see discussion preceding). Follow the directions to clean pads as necessary (see discussion to follow).
- Filter screen missing from pad face: This screen helps prevent debris from plugging the vacuum hose and the air filter. Replace any missing screen immediately (see REPLACEMENT PARTS LIST).
- Nicks, cuts or abrasions in sealing edges: Pad damage can reduce the lifting capacity of the lifter. Replace any damaged pad immediately (see REPLACEMENT PARTS LIST).

 **WARNING: Replace vacuum pad if sealing edge has any nicks, cuts or abrasions.**

- Wear, stiffness or glaze: See Friction Coefficient preceding. Replace any pad that exhibits wear, stiffness or glaze (see REPLACEMENT PARTS LIST).

Cleaning

Regularly clean the face of each vacuum pad to remove oil, dust and any other contaminants. Acceptable cleaning agents include soapy water, glass cleaner and alcohol. Do *not* use other solvents, petroleum-based products (including kerosene, gasoline and diesel fuel) or any harsh chemicals for cleaning, because they can damage the pad and create a hazard to the operator or others.

 **WARNING: Never use solvents, gasoline or other harsh chemicals to clean vacuum pad.**

To prevent liquid from contaminating the vacuum system during cleaning, cover the suction hole in the recess for the filter screen or make sure the pad faces downward. Use a clean sponge or lint-free cloth to apply an appropriate cleanser and wipe the pad face clean. A toothbrush (or similar brush with bristles *that do not harm rubber*) may be used to remove contaminants clinging to sealing edges.¹³ Rinse all residue from the pad face, and allow the pad to dry completely before using the lifter.

VACUUM TEST

Test the vacuum system for leakage routinely, as directed in the preceding INSPECTION and TESTING SCHEDULES.

- 1) Clean the face of each vacuum pad as previously directed (see VACUUM PAD MAINTENANCE: Cleaning).
- 2) Apply the lifter to a clean, smooth, nonporous surface. The surface should be flat or possess no more curvature than the lifter is designed for (if any).¹⁴ When the pumping cycle is completed, the vacuum level should register above 16" Hg [-54 kPa] on the vacuum gauge (if not, see VACUUM SWITCH ADJUSTMENT to follow).
- 3) After the vacuum pump stops running, leave the pads attached to the surface and interrupt the energy flow from the battery: Disconnect the electrical connector uniting the battery to the vacuum generating system.

Note: After the vacuum test is completed, move the valve handle to the "RELEASE" position (power *off*) before reconnecting the battery.

- 4) Monitor the vacuum gauge: *The vacuum level should not decrease by more than 4" Hg [-14 kPa] in 10 minutes.*

 **WARNING: If lifter fails vacuum test, discontinue use immediately.**

Correct any deficiency in the vacuum system before using the lifter. Contact Wood's Powr-Grip or an authorized dealer for assistance.

Note: One or more wiring diagrams are provided in the final section of this *INSTRUCTIONS* manual for reference when servicing the lifter or trouble-shooting a deficiency.

¹³ If these cleaning methods are not successful, contact Wood's Powr-Grip or an authorized dealer for assistance.

¹⁴ Any test material used must be fully and independently supported, and capable of bearing the lifter's weight. Do not use the lifter to lift the test material during the vacuum test.

AIR FILTER MAINTENANCE

(for 1 oz [30 ml] bowl size filters)

Filter Function and Conditions Requiring Service

An air filter prevents solid particles and liquid from contaminating components in the vacuum system.

CAUTION: *Examine air filter regularly and empty when necessary.*

Liquid must not contact any portion of the filter element; remove trapped liquid regularly. Replace the element if it has an overall dirty appearance, or if there is a noticeable increase in the time required to attain full vacuum. (Refer to REPLACEMENT PARTS LIST for filter element kit.)

Filter Service Procedures

- 1) Unscrew the bowl (6) from the body (1). Support the body while twisting the bowl, to protect the vacuum line fittings from being damaged.
- 2) Determine whether the filter element (4) needs to be replaced (see Conditions Requiring Service preceding). *If so*, proceed to step 3. *If not*, remove any liquid or contaminants from the bowl; clean the old bowl seal (2) with mild soap and water; and skip to step 7.
- 3) Unscrew the element holder (5) and remove all internal parts.
- 4) Set aside the element, element gaskets (7) and bowl seal for disposal later.
- 5) Clean all other internal parts and the bowl, using mild soap and water only. *Do not* use any other cleansing agents.
- 6) Place the new element gaskets and element, along with the old deflector (3), on the element holder, and screw the assembly back into the filter body (tighten gently, finger tight).
- 7) Lubricate the new or cleaned bowl seal (2)¹⁵, using a mineral base oil or grease (such as the lubricant furnished in the filter element kit). *Do not* use synthetic oils, such as esters, and *do not* use silicones.
- 8) Place the bowl seal around the rim of the bowl. Then screw the bowl back into the body, taking care to avoid contaminating the filter element with lubricant. Hand-tighten only.
- 9) Test the vacuum system to be certain the air filter does not leak (see VACUUM TEST preceding, if applicable).

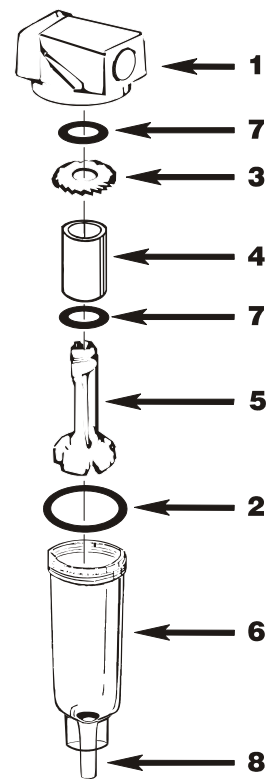

⚠ WARNING: When the air filter is being used on a *vacuum* system, rather than with pressure, using the twist drain (8) to remove liquid from the bowl is **not** recommended. **Never** disturb the twist drain, as contaminants could lodge in the drain seal and cause a vacuum leak.

¹⁵ The filter element kit may contain two sizes of bowl seals (O-ring type gaskets). If so, use the smaller bowl seal; or if in doubt, compare the old bowl seal to determine the appropriate size.

VACUUM PUMP MAINTENANCE

(for Thomas pump nos. 107BA20964, 107BD20964 & 107CDC20)

⚠ WARNING: Before proceeding with any maintenance, disconnect power source.

If the vacuum pump (14) takes too long to attain full vacuum, it may require maintenance (see Vacuum Apply and Release Times in SPECIFICATIONS, if applicable). Replace the diaphragm, valve flappers or head gasket as necessary to obtain acceptable pump performance.

Replacing the Diaphragm (13)

- 1) Remove the four head screws (1) and remove the head (2).
- 2) Remove the four diaphragm hold-down screws (10) and the diaphragm hold-down plate (12).
- 3) Replace the diaphragm (13) and reverse the above procedure for reassembly.

Replacing the Intake Valve Flapper (11)

- 1) Remove the four head screws (1) and remove the head (2).
- 2) Remove the intake valve flapper screw (8) and the intake valve keeper (7).
- 3) Replace the intake valve flapper (11) and reverse the above procedure for reassembly.

Replacing the Exhaust Valve Flapper (5) and Head Gasket (15)

- 1) Remove the four head screws (1) and remove the head (2).
- 2) Turn the head upside-down and remove the four valve plate screws (9).
- 3) Lift out the valve plate (6) to access the exhaust valve flapper and head gasket.¹⁶
- 4) Remove the exhaust valve flapper screw (3) and the exhaust valve keeper (4), and replace the exhaust valve flapper (5).
- 5) Replace the head gasket (15), and reverse the above procedure for reassembly.

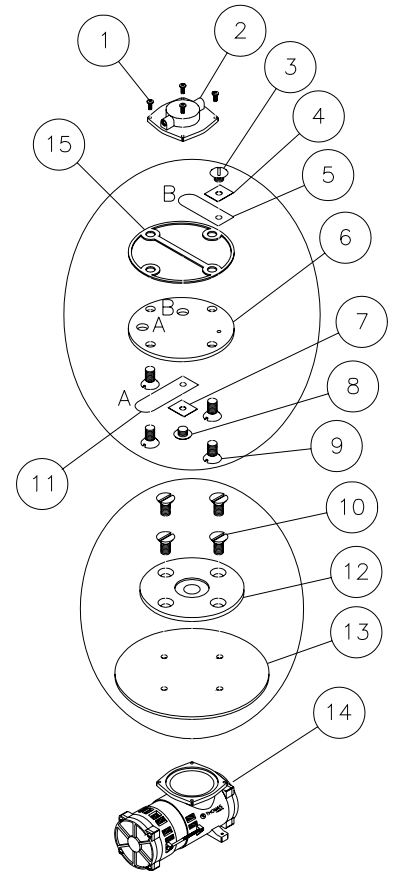

1 HEAD SCREWS

2 HEAD

3 EXHAUST VALVE FLAPPER SCREW

4 EXHAUST VALVE KEEPER

5 EXHAUST VALVE FLAPPER

6 VALVE PLATE

7 INTAKE VALVE KEEPER

8 INTAKE VALVE FLAPPER SCREW

9 VALVE PLATE SCREWS

10 DIAPHRAGM HOLD-DOWN SCREWS

11 INTAKE VALVE FLAPPER

12 DIAPHRAGM HOLD-DOWN PLATE

13 DIAPHRAGM

14 VACUUM PUMP

15 HEAD GASKET

¹⁶ **CAUTION:** Depending on the product, the vacuum system may require the valve plate (6) to be rotated to an orientation different from the one shown. When removing the valve plate, always take note of its orientation in the pump head (2), and install the valve plate the same way during reassembly. In all cases, the valve plate must be oriented so that its intake hole is matched with the head port that connects to the check valve.

VACUUM SWITCH ADJUSTMENT

Vacuum Switch Function¹⁷

A vacuum sensor/electrical switch assembly controls the low vacuum warning light and the vacuum pump: The valve handle activates the warning light and the pump, which evacuates the vacuum pads.¹⁸ After the lifter attains a vacuum level sufficient for lifting the maximum load weight (hereafter, “minimum lifting level”), the vacuum switch automatically turns off the pump and the warning light.¹⁹ In order to maintain sufficient vacuum, the vacuum switch automatically turns on the pump and warning light again before vacuum decreases to a level that is lower than the minimum lifting level.

Conditions Requiring Readjustment

At the factory, the vacuum switch is set to maintain the minimum vacuum level specified for the Load Capacity (see SPECIFICATIONS). However, shipping vibrations or shocks, normal wear, or other conditions may adversely affect this adjustment. Periodically verify the switch adjustment by comparing how the vacuum pump and the low vacuum warning light function in relation to the vacuum level registered on the vacuum gauge, as follows:

- If the pump and the warning light do not *turn off after* vacuum increases to a level much *higher* than the minimum lifting level, the vacuum switch may be adjusted to maintain a lower vacuum level. Otherwise, the pump would continue to run unnecessarily after the lifter has attained sufficient vacuum to lift the maximum load weight.
- If the pump and the warning light do not *turn on before* vacuum decreases to a level *lower* than the minimum lifting level, the vacuum switch ***must be adjusted to maintain a higher vacuum level.***²⁰ Otherwise, the lifter would not maintain sufficient vacuum to lift the maximum load weight.

¹⁷ Lifters equipped with the Dual Vacuum System have 2 vacuum switches. Directions are the same for these lifters ***except that each vacuum switch must be tested and adjusted individually.*** When you are evaluating vacuum system functions under Conditions Requiring Readjustment, remember that each vacuum switch corresponds with one vacuum gauge and one vacuum circuit. After you have removed the cover from the enclosure with the vacuum switches, you can trace the vacuum lines to determine which components are connected to one another.

¹⁸ If the warning light does not turn on when the valve handle is moved to the “APPLY” position, the light bulb may be burned out. Replace the bulb when necessary.

¹⁹ When using the lifter at high elevations, reduced atmospheric pressure may prevent the vacuum generating system from attaining the vacuum level set at the factory. In this case, the pump would continue to run and the warning light would stay illuminated continuously. If the ability to lift the maximum load weight is not required, the operator can adjust the vacuum switch to maintain a lower vacuum level, allowing the pump to cycle normally. However, be advised that ***lifting capacity decreases proportionally with decreasing vacuum***, based on the vacuum level specified for the Load Capacity (see SPECIFICATIONS). For example, if a lifter's Load Capacity is rated at 16" Hg [-54 kPa], lifting capacity decreases by 6.25% for each inch of Hg subtracted from (or for each 3.4 kPa added to) the vacuum level. ***Always maintain a minimum vacuum level of 10" Hg [-34 kPa]***, regardless of the vacuum level specified for the original Load Capacity. In addition, lifter markings should be adjusted to reflect the revised Load Capacity and the vacuum gauge should be marked to indicate the revised minimum lifting level.

²⁰ In order to observe lifter functions while vacuum is decreasing, it may be necessary to create a controlled leak in the vacuum system (eg, by breaking the seal between one or more vacuum pads and the test surface).

Adjustment Procedure

⚠ WARNING: *Lifting capacity decreases whenever vacuum switch is adjusted to maintain lower vacuum level.*

- 1) Using a 1/4" open-end wrench (as provided), turn the adjustment screw about 1/6th turn at a time (approximately one flat of the screw head).

To maintain a *lower* vacuum level, turn the screw *clockwise* (when viewing vacuum switch from end with electrical connectors).

To maintain a *higher* vacuum level, turn the screw *counter-clockwise* (when viewing vacuum switch from end with electrical connectors).

- 2) Recheck the vacuum switch setting following each 1/6th turn of the adjustment screw. In order to test the adjustment accurately, release the vacuum pads completely before reapplying them to a test surface.

When the vacuum switch is adjusted correctly, the vacuum pump turns off only *after* vacuum increases to a level higher than the minimum lifting level; and the pump turns on again *before* vacuum decreases to a level lower than the minimum lifting level.

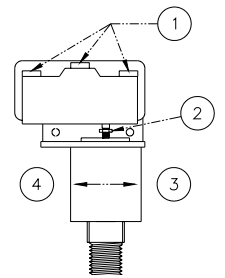

- 1 ELECTRICAL CONNECTORS
- 2 ADJUSTMENT SCREW
- 3 TO MAINTAIN HIGHER VACUUM
- 4 TO MAINTAIN LOWER VACUUM

REPLACEMENT PARTS LIST

Stock No.	Description	Qty.
93212	Vacuum Control Valve w/Handle	1
66195	Pump Repair Kit (including diaphragm, head gasket and valve flappers)	1
66130	Vacuum Pump - Diaphragm Type - 1-SCFM [28 liters/minute] - 12 V DC	1
65430	Vacuum Hose - 7/32" [5.6 mm] ID (approx. 108" [275 cm] in length)	1
65300	Handle Grip Foam	1
65211	Check Valve - 1/8 NPT	1
64706AM	Battery Charger - 240 V AC	1
64702AM	Battery Charger - 100 / 120 V AC	1
64664	Battery - 12 V DC - 7 Amp-Hours	1
64590	Battery Gauge	1
64460	Circuit Breaker - 10 A	1
64283	Bulb - 13 V - Bayonet (for low vacuum warning light)	1
64254	Red Lens (for low vacuum warning light)	1
64236	Vacuum Switch - 1/4 NPT	1
64230	Roller-Lever Switch	1
64200	Push-Button Switch (for battery test button)	1
57012	Pad Channel Tilt Pin	1
54392	Battery Connector - Twin Lead	1
54214	Foam Washer	1
53132	Hose Fitting - Tee - 5/32" [4.0 mm] ID	2
53126	Pad Fitting - Tee - 3/64" [1.2 mm] ID	2
53120	Pad Fitting - Elbow - 3/64" [1.2 mm] ID	2
49646T	Vacuum Pad - Model G3370 / 11" [28 cm] Diameter - Lipped	4
49614	Vacuum Pad - Model HV11F / 10" [25 cm] Diameter - Lipped w/Foam Ring (option)	4
49605T	Vacuum Pad - Model HV11 / 10" [25 cm] Diameter - Lipped	4
49586TA	Vacuum Pad - Model G0750 / 10" [25 cm] Diameter - Concave	4
49122	End Plug - 2" x 2" x 1/4" [50.8 mm x 50.8 mm x 6.4 mm] Tubing Size	3
29353	Pad Cover	4
20270	1/4" [6.4 mm] Open-End Wrench (for adjusting vacuum switch)	1
16134	Filter Element Kit (for 1 oz [30 ml] bowl size air filter)	1
15910	Vacuum Gauge - 1/8 NPT - CBM Type	1
15792	Rotation Release Lever Knob	1
15632	Pad Filter Screen - Small (for G0750 pad)	4
15630	Pad Filter Screen - Large (for G3370 & HV11 pads)	4

***SERVICE ONLY WITH IDENTICAL REPLACEMENT PARTS
SUPPLIED BY OR APPROVED BY WOOD'S POWR-GRIP CO., INC.***

LIMITED WARRANTY

Powr-Grip products are carefully constructed, thoroughly inspected at various stages of production, and individually tested. They are warranted to be free from defects in workmanship and materials for a period of one year from the date of purchase.

If a problem develops during the warranty period, follow the instructions hereafter to obtain warranty service. If inspection shows that the problem is due to defective workmanship or materials, Powr-Grip will repair the product without charge.

WARRANTY DOES NOT APPLY WHEN:

Modifications have been made to the product after leaving the factory.

Rubber portions have been cut or scratched during use.

Repairs are required due to abnormal wear and tear.

The product has been damaged, misused, or neglected.

If a problem is not covered under warranty, Powr-Grip will notify the customer of costs prior to repair. If the customer agrees to pay all repair costs and to receive the repaired product on a C.O.D. basis, Powr-Grip then will proceed with repairs.

TO OBTAIN REPAIRS OR WARRANTY SERVICE

For purchases in *North America*:

Contact the Technical Service Department at Wood's Powr-Grip Co.. When factory service is required, ship the complete product--prepaid--along with your name, address and phone number to the street address hereafter.

For purchases in *all other localities*:

Contact your dealer or the Technical Service Department at Wood's Powr-Grip Co. for assistance.

Wood's Powr-Grip Co., Inc.
908 West Main St. / P.O. Box 368
Laurel, MT USA 59044

phone 800-548-7341

phone 406-628-8231

fax 406-628-8354